

# Characterizing the Robustness of Wi-Fi and Bluetooth against Continuous Wave EM Disturbances inside a Reverberation Chamber

Aleksandr Ovechkin  
*ESAT-WaveCoRe, M-Group*  
*KU Leuven Bruges Campus*  
Bruges, Belgium  
aleksandr.ovechkin@kuleuven.be

Tim Claeys  
*ESAT-WaveCoRe, M-Group*  
*KU Leuven Bruges Campus*  
Bruges, Belgium  
tim.claeys@kuleuven.be

Dries Vanoost  
*ESAT-WaveCoRe, M-Group*  
*KU Leuven, Bruges Campus*  
Bruges, Belgium  
dries.vanoost@kuleuven.be

John F. Dawson  
*Dept. of Electrical Engineering*  
*University of York*  
York, United Kingdom  
john.dawson@york.ac.uk

Guy A. E. Vandebosch  
*ESAT-WaveCoRe*  
*KU Leuven*  
Leuven, Belgium  
guy.vandebosch@kuleuven.be

Davy Pisssoort  
*ESAT-WaveCoRe, M-Group*  
*KU Leuven*  
Bruges, Belgium  
davy.pissoort@kuleuven.be

**Abstract**—This paper describes a detailed test setup and procedure to characterize the robustness of Wi-Fi3 and Bluetooth 4.2 against continuous wave electromagnetic disturbances inside a reverberation chamber. Bluetooth 4.2 robustness was also characterized by continuous broadband noise. These experiments aim to reveal the susceptibility of commonly used wireless communication protocols against continuous wave noise. Results show that Wi-Fi3 has an abrupt rise in the packet error rate (up to  $\approx 100\%$ ) when the continuous wave noise overlaps with the Wi-Fi3 working frequency. Bluetooth 4.2 is robust against continuous wave noise, thanks to the frequency hopping technique, but fails against broadband noise.

**Index Terms**—Electromagnetic interference, EMI, Electromagnetic disturbance, EMD, Continuous Wave noise, CW, Narrowband interference, Broadband interference, IEEE 802.11g, Bluetooth

## I. INTRODUCTION

The time when the "wired age" of technology prevailed is ending, giving way to the era of wireless technologies. Nowadays the use of wireless devices is ubiquitous: we use devices working on wireless technologies from our daily activities at home (smart homes, speakers, fitness trackers, etc) to healthcare applications and safety-critical systems (blood pressure monitors, autonomous driving).

In this paper, we discuss the robustness of two prominent wireless technologies: IEEE 802.11g (or Wi-Fi 3) and Bluetooth 4.2 (BT). The annual growth of devices using these communication protocols is making rapid strides. The number of BT devices in 2020 reached 4.6 billion devices [1], while the number of wireless local area network (WLAN) connected

The research leading to these results has received funding from the European Union's Horizon 2020 research and innovation programme under the Marie Skłodowska-Curie Grant Agreement No 812.788 (MSCA-ETN SAS).

This publication reflects only the authors' view, exempting the European Union from any liability. Project website: <http://etn-sas.eu/>.

devices topped 18.2 billion in 2020 [2]. Note that there are other wireless technologies, which are also widely used (LoRa, Sigfox, Zigbee, LTE, 5G NR, etc). With such a big increase in devices, the allocated working bandwidth for each device can overlap what leads to Electromagnetic Interference (EMI). EMI itself can be either intentional or unintentional. This paper focuses on the latter. Unintentional EMI may occur due to the use of different communication protocols within the same allocated bandwidth. For example, in [3] the author clearly shows that in different parts of the world the aforementioned wireless communication protocols can work within the same frequency range which significantly increases the chances of EMI.

EMI unavoidably happens from time to time. According to [4], interference can be classified into three groups: permissible, accepted, or harmful. The main stakeholders define the "rules of thumb" for the allowed data corruption and data loss (which are described by the Bit Error Rate or BER and Packet error rate or PER, respectively). These allowed BER and PER values differ for the specific application purpose. For instance, the infotainment services allow higher BER and PER rates in comparison to safety-critical systems (e.g. Vehicle-to-Everything or V2X) or medical systems (blood pressure monitors). EMI can be roughly categorized into two types: broadband (which can be caused by power transmission lines, plasma TV sets, and others) and narrowband (garage door openers, mobile phones, radio/TV stations, and others). These types of EMI will be covered in the following Sections of this paper with the narrowband EMI being as the main focus.

Narrowband interference can be simplified and represented as a single sine wave. This is the reason why it is sometimes called Continuous Wave (CW) electromagnetic disturbance (EMD). This kind of disturbance should be taken into account

when testing safety-critical applications. For example, [5] raises the problem of 5G NR (New Radio) vulnerability to CW EMD, while [6] describes not only the need for but also the evaluation procedure of interference by CW EMD for V2X applications. Let us take the automotive sector, having very stringent communication requirements, as an example. According to [7] autonomous vehicles should have an end-to-end latency of a maximum of 5 ms between the V2X application server and safety-related V2X user equipment application with a downlink data rate equal to 1 Mb/s. BER is the ratio between bit errors and the total number of bits. If we can detect these erroneous bits then the system can either ask for retransmission of the packet or switch to a minimum risk state. The retransmission case will increase the end-to-end latency value what in some safety-critical systems is intolerable[7].

In this paper, we analyze the performance of BT and Wi-Fi3 in a noisy environment which is represented by a single CW EMD. The effect is worsened by considering this in a reverberant environment. In Section II the test setup of the experiment in a Reverberation Chamber (RC) is described. Section III provides the experimental part defining the layout for the experiments along with the test parameters. Section IV provides the experimental results obtained in different chambers with their subsequent analysis, while Section V draws concluding remarks.

## II. TEST SETUP DESCRIPTION

### A. RC parameters

All the experiments described in this paper were conducted in the RC located at the KU Leuven’s Bruges Campus (RC1) and then were compared with the same experiments conducted in the RC of the University of York (RC2). Each RC has several parameters which have to be taken into account while conducting experiments. They are:

- 1) RC dimensions;
- 2) the lowest usable frequency (LUF).

The above-mentioned parameters allow us to identify the “working volume” of the chamber in which the electromagnetic (EM) field can be assumed to be uniform and statistically isotropic.

The key-parameters of the RCs are presented in Table I.

### B. Test setup

The idea of the test was to start up CW EMD and monitor its effects while Wi-Fi3 or BT communication was established. A signal generator was used as a source for the CW EMD.

TABLE I: RC key-parameters

Room	Length, m	Width, m	Height, m
RC1	2.4	4.2	2.775
RC2	4.7	3.0	2.37
LUF = 300MHz			

The noise was radiated in the chamber using an antenna, specified in Table II. The Devices Under Test (DUTs) which were communicating during the test procedure were Raspberry Pi (RPI) radios. One of the RPIs was assigned as a client (or “Master”) and was connected to the control computer via the shielded Ethernet cable (category 6A). The other RPI acted as a server (or “Slave”) meaning that it had a connection with the client via the wireless communication link. The communication between the client and the server was similar to the “ping procedure”: the client sent packets, the server received them, and then sent them back. If the packet was not returned to the client during a certain waiting time (in the experiments this time was set to 100 ms and 200 ms for RC1 and RC2, respectively) or was returned but the data did not match the originally sent packet then it was counted as an error. The packets were transmitted using the Transmission Control Packet (TCP) enabling packet retransmission. With the retransmission option, one may analyze the effect of CW EMD on transmitted packets using the full protocol stack. If a packet is retransmitted after the first failure of transmission, it does not count as a packet error since the packet did arrive after the retransmission. After the whole experiment, the Packet Error Rate (PER) was determined.

The server was receiving commands from a computer to:

- 1) establish a wireless connection;
- 2) initialize scripts written in Python on both the client and the server side.

A more detailed description of the test procedure is described in Section III.

Depending on the chamber (RC1 or RC2) different equipment (transmitting/receiving antennas, attenuators, amplifiers, E-field probe) were used. The main differences are outlined in Table II.

Not only the equipment was different but the stirrer operation as well. For RC1 a constant speed of one rotation per second for the stirrer was used, while for the RC2 the stirrer moved in steps making a full turn within approximately three seconds. In addition to this, the decay time of the chambers was different. To establish the connection between RPIs in

TABLE II: Equipment difference for RC1&RC2

Purpose	RC1	RC2
CW EMD generation	Signal generator[8] + Broadband amplifier[9]	Signal generator[8]
Antenna inside RC	Double Ridged Broadband Horn Antenna[10]	Blade antenna[11]
Additional equipment	E-field probe[12]	Blade antenna + 20 dB attenuator + spectrum analyzer[13]

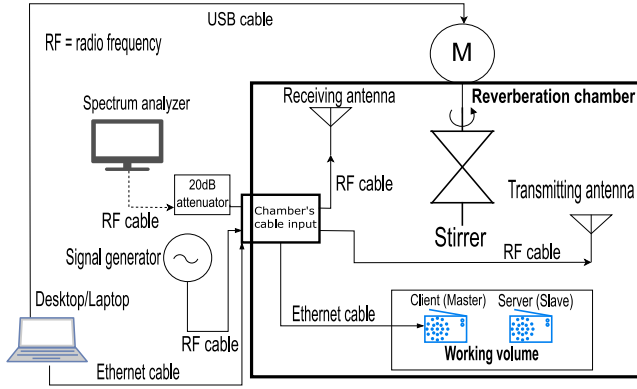

Fig. 1: Test setup for experiments in RC2

RC2 without packet loss, AN79 absorbing material [14] (one full AN79 and a part of it,  $\approx 13.7\%$ ) was added. A schematic overview of the test setup and its actual representation (layout) for experiments in RC2 are shown in Figs. 1 and 2. Test setup and its layout for RC1 differ from the ones for RC2 according to the differences given in Table II.

### III. EXPERIMENTAL PART

During the experiments, the RPis were put in the working volume[15] of RC1 and RC2.

An overview of the test parameters is given in Table III.

The test procedure can be outlined in the following steps:

- 1) Connection initialization between RPis. Here the laptop (see Fig. 1) starts up the TCP connection (Wi-Fi3 or BT) between two RPis via the Ethernet cable, so packets can be sent.
- 2) The laptop via the cable initializes the stirrer which comes into motion.
- 3) The signal generator (in combination with an amplifier, if needed) starts to send a continuous wave signal with a certain frequency and power.

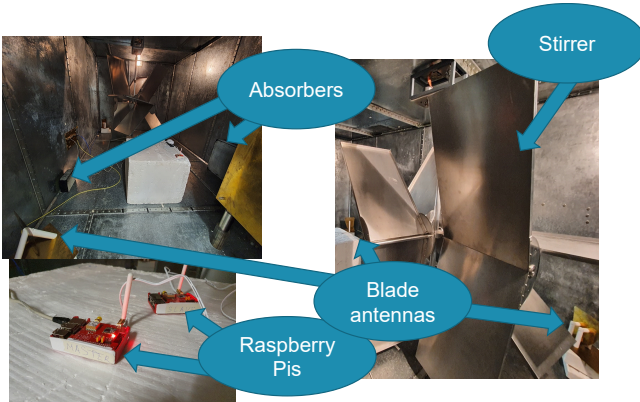

Fig. 2: Test layout for experiments in RC2

TABLE III: Test parameters

Experiment parameters		
Parameter	Value	
	RC1	RC2
Tested wireless protocols	Wi-Fi3, BT	Wi-Fi3
Stirrer speed, rev/s	1	1/3
CW EMD power, <sup>1</sup> dBm	-7.8 — 12.2 for Wi-Fi3, 32.5 — 52.5 for BT	-50 — -26
Power step, dBm	0.2	0.5
CW EMD Frequency, GHz	2.395 — 2.426	2.399 — 2.433
Frequency step, MHz	1	
Number of transmitted packets	1000	
Wireless protocols' parameters		
Parameter	Wi-Fi3	BT
Operational frequency, GHz	2.401 — 2.483	2.400 — 2.4835
Working frequency, GHz	2.401 — 2.423, first channel	2.4000 — 2.4835 GHz

<sup>1</sup> The forward power of CW EMD which goes to the chamber.

- 4) RPis start the communication by sending packets between each other (first, the client sends a packet, then the server receives it and sends it back).
- 5) Monitoring:
  - a) the time needed to send all the packets;
  - b) the E-field inside the RC1.
- 6) Using a sufficient number of received packets allows calculating the PER in accordance with (1)

$$PER = 1 - \frac{\text{Received packets}}{\text{Total amount of packets}} \quad (1)$$

- 7) If the PER value is less than 100%, then depending on the frequency value either steps 3 — 6 are repeated or the test procedure ends, else depending on the power value the test procedure goes to the next power with the same frequency or to the next frequency (if the maximum power has been reached).

The test procedure goes through all the frequency and power values predefined by the user. In the end, measured values of PER, packet transmission, CW EMD parameters (frequency and power) are saved and analyzed. The abovementioned test procedure is visualized in a flowchart shown in Fig. 3.

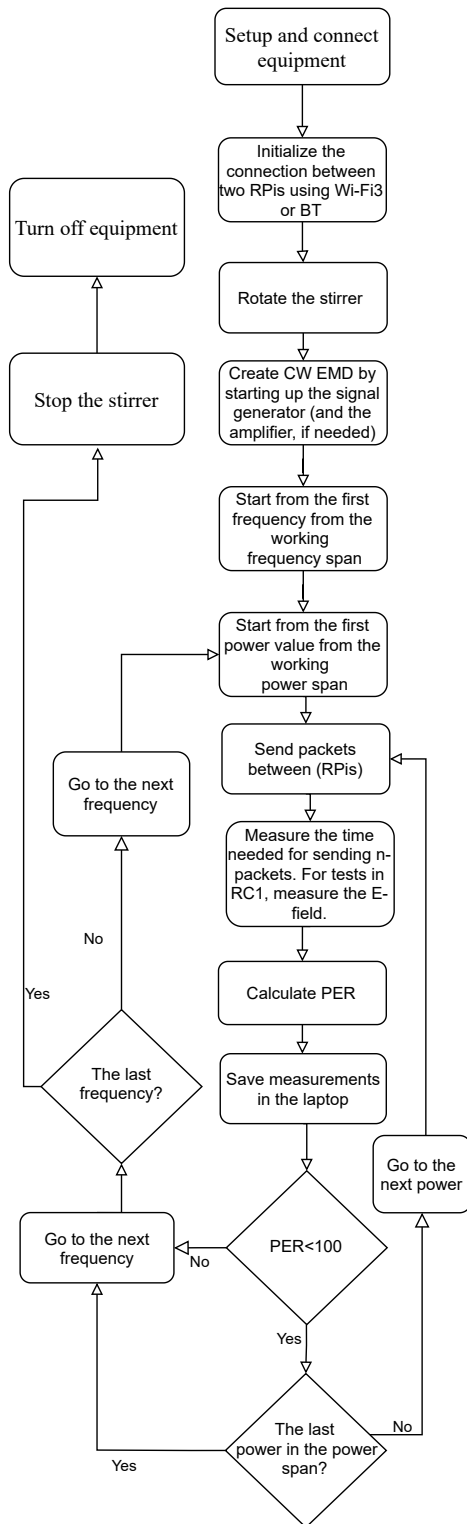

Fig. 3: Test procedure flowchart

#### IV. EXPERIMENTAL RESULTS

##### A. Wi-Fi3 results. RC1

During the experiment, the CW EMD power was injected into the chamber throughout the frequency span bigger than

the working frequency. At the same time, there were identified frequencies at which the communication was inhibited but the packet transmission could still take place. The E-field measurements (for better accuracy the E-field probe during every transmission took five subsequent measurements and then averaged the result) on these frequencies were averaged and later used on heatmaps (Figs. 4 and 5) on the horizontal axis, while CW EMD's frequencies could be seen on the vertical axis.

The color indication on the heatmaps represents either the PER values (Fig. 4) or the packet transmission duration (Fig. 5).

One may notice that injection of CW EMD out of the working Wi-Fi3 channel does not cause interference, so PER is very low (light yellow color on the heatmap) and starts to influence the Wi-Fi3 performance only at frequencies close to the working channel (2.4 GHz at E-field close to 1.7 V/m on Fig. 4). When CW EMD is exactly on the frequency, at which the RPIs communicate, the PER may already reach 100% at 2.403 GHz for the E-field  $\approx 1.1$  V/m (what is close to a realistic scenario [16]). Some companies introduce their key performance indicators (KPIs) for wireless local area network communication or WLAN (Wi-Fi3 is a part of it). For instance, PER is one of such KPIs that is assumed to be admissible for WLAN communication when it does not exceed  $\approx 20\%$  [3]. Fig. 4 shows that this value is reached from the beginning throughout the whole working frequency band except for side frequencies (2.401 and 2.423 GHz) and the center frequency 2.412 GHz. Note that the PER heatmap shows a sudden drop of the PER almost to zero at 2.412 GHz, exactly at the center frequency of the 1<sup>st</sup> Wi-Fi3 channel. Some transmitters may cause power leakage of the carrier at the center frequency. This leads to DC offset [17]. IEEE 802.11 communication protocols (Wi-Fi3 is among them) always have the center frequency as a null subcarrier [18] meaning that it does not carry information. This explains such a drop in PER values throughout the full range of CW EMD power.

The packet transmission time shown in Fig. 5 has a logical connection with Fig. 4. When CW EMD happens at frequencies outside the chosen Wi-Fi working channel, the time needed to transmit 1000 packets and receive them back does not exceed 20 s. The packet transmission time abruptly rises (reaching 140 s at some points) throughout almost the whole working channel (2.402 — 2.422 GHz, except for 2.412 GHz). At the center frequency, the transmission time abruptly decreases due to the null subcarrier described above for the case with the PER results. On Fig. 5 at the power and frequency values, where the transmission time values drop to zero (yellow color), the transmission time measurements were not performed since the PER value had already reached 100%.

##### B. Wi-Fi3 results. RC2

Results for the experiments conducted in RC2 can be seen in Figs. 6 and 7. Albeit one may notice a similar trend in PER results (Figs. 4 and 6) the results are different and that is why separated from each other.

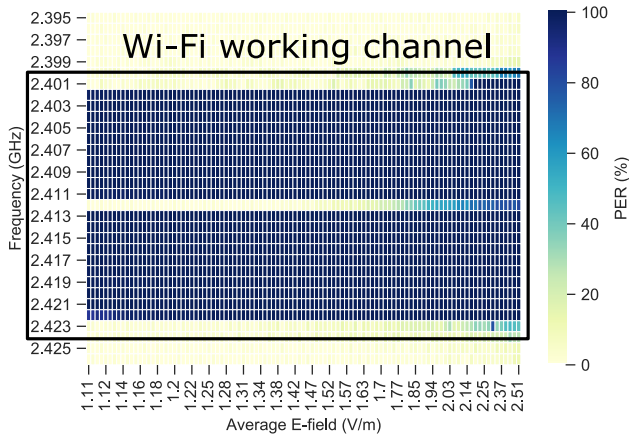

Fig. 4: RC1. PER heatmap depending on CW EMD values

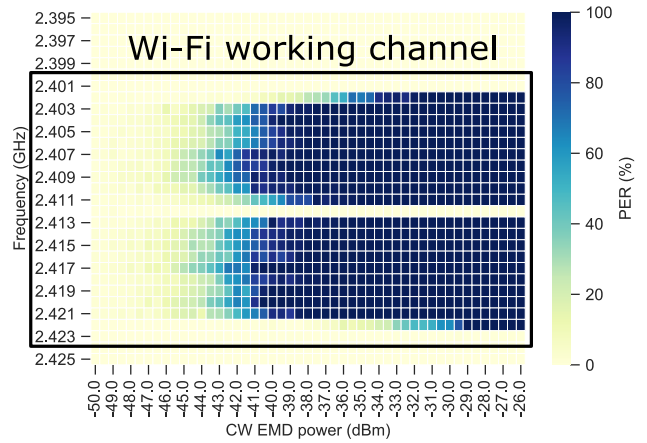

Fig. 6: RC2. PER heatmap depending on CW EMD values

First, the E-field was not measured in RC2, hence the forward power entering RC2 (or the CW EMD power) can be seen on a horizontal axis of the heatmaps (Figs. 6 and 7).

Second, as was mentioned in Section II-B, the waiting time for the chambers was different, hence one may notice a difference in the packet transmission time results shown on Figs. 5 and 7, respectively.

Finally, the chamber parameters (decay time, chamber insertion loss, etc) also affected the results in terms of their absolute values. Nevertheless, the explanation of the behavior of PER or packet duration time outside and within the Wi-Fi3 working frequency which was made for RC1 is also valid for RC2.

### C. BT results. RC1

BT implements a frequency-hopping technique [19] allowing it to choose the least busy channels for the following communication. This property is widely used for constructing anti-jamming systems (e.g. [20]). The experiments conducted

on this wireless communication protocol showed that BT is more robust to CW EMD. When CW EMD is located at any of the working BT channels, the frequency-hopping technique identifies these channels as if they are already busy with some other communication, so the real communication between RPIs hops to another channel free from noise. Therefore, it was decided to check BT performance with the presence of the continuous broadband noise covering all the 79 BT channels and limited to 2.4 — 2.5 GHz frequency range. It was assumed that the frequency-hopping technique would fail when all the working channels would be "busy".

In Fig. 8 it can be seen that the above assumption is correct. It can be noticed that BT struggles more and more to establish the connection between RPIs as the disturbance power increases. At  $\approx 2.3$  V/m, it finally gives up to the continuous broadband EMD. The transmission time drops when PER reaches its maximum because the connection is lost starting from  $\approx 2.3$  V/m and transmission time, therefore,

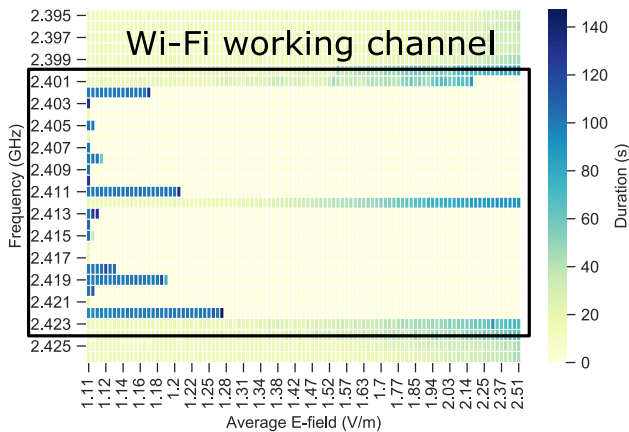

Fig. 5: RC1. Packet transmission time heatmap depending on CW EMD values

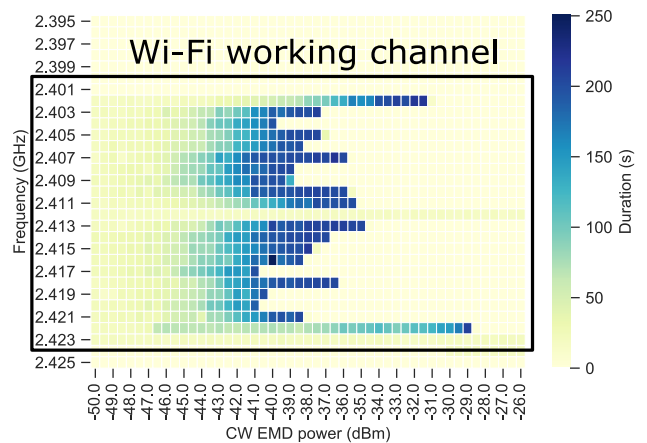

Fig. 7: RC2. Packet transmission time heatmap depending on CW EMD values

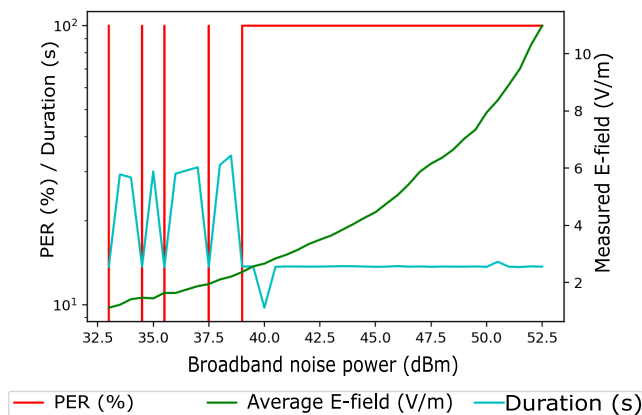

Fig. 8: BT vs continuous broadband EMD

becomes the waiting time of the program for establishing the communication between RPIs. The E-field of 2.3 V/m in the presence of the continuous broadband EMD is quite strong taking into account that Wi-Fi3 already fails at 1.1 V/m for CW EMD what is a single frequency noise. This means that one may need more power to disturb the BT connection. If one wants to compare Wi-Fi3 and BT results performed in RC1 further, one should note that though the BT test was performed in the same chamber, the location of RPIs and the noise radiating antenna were different. In addition, the transmit powers of Wi-Fi and BT were not exactly the same but they were both at the maximum allowed level of their own protocol. Finally, the distance between both master and slave would also have an influence on real-life applications. However, it would not change the conclusion that Wi-Fi communication is more susceptible to the CW EMD than BT.

## V. CONCLUSION

In this paper, an experimental setup for characterizing the robustness of Wi-Fi3 and BT against CW EMD in RC was proposed. BT was additionally tested against the continuous broadband EMD because the experiments showed its immunity to CW EMD thanks to the frequency-hopping technique allowing to choose the least "busy" channels. During the continuous broadband EMD, the BT communication was disrupted at the E-field of 2.3 V/m. This E-field is quite high, especially considering that Wi-Fi3 has already been impaired at 1.1 V/m for a single frequency disturbance. This means that BT communication requires more noise power to be disturbed.

The results achieved for the PER measurements and conducted in two different RCs have similarities. The presented results show that when CW EMD overlaps with the Wi-Fi3 bandwidth, Wi-Fi3 has  $PER \approx 100\%$  already at 1.1 V/m. Packet transmission time and E-field are directly linked to PER values.

The intention of this work was not to perform a true A-to-B comparison between Wi-Fi3 and BT. The described experiments aim to increase the awareness of the scientific society and the potential Wi-Fi user about the need of taking

into account CW EMD as a source of EMI which can seriously hinder Wi-Fi communication.

Wi-Fi3 is based on a technique that will be used in autonomous systems, that is why further work on the CW EMD impact on Wi-Fi-based protocols will be investigated.

## REFERENCES

- [1] Bluetooth SIG, "Bluetooth Market Update 2020," pp. 1–37, 2020.
- [2] B. Rojas and H. Ujhazy, "Asia Pacific (Excluding Japan) Wireless SD-WAN Market Forecast & Analysis 2017-2021," no. October 2017, pp. 2016–2021, 2021.
- [3] N. Mahmud, "OVER-THE-AIR TESTING OF AUTOMOTIVE COMMUNICATION SYSTEMS AT VEHICLE LEVEL," *Rohde&Schwarz webinar*, 2020.
- [4] ITU, "Internacional Telecommunication Union, RR1-1. CHAPTER 1 - Terminology and technical characteristics ARTICLE 1 - Terms and Definitions," 1.15, pp. 1–19, 2009.
- [5] Fors, Karina and Axell, Erik and Linder, Sara and Stenumgaard, Peter, "On the Impact of CW interference on 5G NR," *EMC Europe 2019 - 2019 International Symposium on Electromagnetic Compatibility*, pp. 1049–1054, 2019. [Online]. Available: <http://dx.doi.org/10.1109/EMCEurope.2019.8871665>
- [6] Claeys, Tim and Ovechkin, Aleksandr and Pissoort, Davy, "The Need For and How To Evaluate Continuous Wave Immunity of Wireless Systems used in V2X Applications," 2020. [Online]. Available: <http://dx.doi.org/10.1109/emceurope48519.2020.9245766>
- [7] 3GPP, "3GPP TR 22.886 V16.2.0 (2018-12) 3rd Generation Partnership Project; Technical Specification Group Services and System Aspects; Study on enhancement of 3GPP Support for 5G V2X Services (Release 16)," 2018.
- [8] "R&S@ SMB100A RF and Microwave Signal Generator. Operating Manual."
- [9] "R&S@ BBA150 Broadband Amplifier. Specifications."
- [10] "Schwarzbeck. Double Ridge Broadband Horn Antenna BBHA 9120D."
- [11] Marvin, Andrew C. and Esposito, Giuseppe and Dawson, John F. and Flintoft, Ian D. and Dawson, Linda and Everard, Jeremy A.K. and Melia, Gregory C.R., "A wide-band hybrid antenna for use in reverberation chambers," *IEEE International Symposium on Electromagnetic Compatibility*, pp. 222–226, 2013. [Online]. Available: <http://dx.doi.org/10.1109/ISEMC.2013.6670413>
- [12] "Narda. Electric field probe PMM EP600. User's Manual."
- [13] "Agilent Technologies. Getting Started Guide. ESA Series Spectrum Analyzers," no. May, 2002.
- [14] Laird ECCOSORB AN, "Flexible Foam Sheet Broadband Microwave Absorber."
- [15] Zarai, Faouzi and Boudriga, Noureddine and Obaidat, Mohammad S., "Universal Mobile Telecommunications System," *Handbook of Computer Networks*, vol. 2, pp. 699–715, 2011. [Online]. Available: <http://dx.doi.org/10.1002/9781118256114.ch46>
- [16] Koppel, Tarmo and Ahonen, Mikko and Carlberg, Michael and Hedendahl, Lena K. and Hardell, Lennart, "Radiofrequency radiation from nearby mobile phone base stations—a case comparison of one low and one high exposure apartment," *Oncology Letters*, vol. 18, no. 5, pp. 5383–5391, nov 2019. [Online]. Available: <http://dx.doi.org/10.3892/ol.2019.10899>
- [17] Tektronix Inc., "Wi-Fi : Overview of the 802.11 Physical Layer and Transmitter Measurements," p. 44, 2013. [Online]. Available: [http://www.cnrood.com/public/docs/WiFi\\_Physical\\_Layer\\_and\\_Transm\\_Meas.pdf](http://www.cnrood.com/public/docs/WiFi_Physical_Layer_and_Transm_Meas.pdf)
- [18] "802.11 OFDM WLAN Overview." [Online]. Available: [http://rfmw.em.keysight.com/wireless/helpfiles/89600B/ WebHelp/ Subsystems/wlan-ofdm/content/ofdm\\_80211-overview.htm](http://rfmw.em.keysight.com/wireless/helpfiles/89600B/ WebHelp/ Subsystems/wlan-ofdm/content/ofdm_80211-overview.htm)
- [19] Pang, Bozheng and Claeys, Tim and Pissoort, Davy and Hallez, Hans and Boydens, Jeroen, "A Study on the Impact of the Number of Devices on Communication Interference in Bluetooth Low Energy," *2020 29th International Scientific Conference Electronics, ET 2020 - Proceedings*, pp. 18–21, 2020. [Online]. Available: <http://dx.doi.org/10.1109/ET50336.2020.9238240>
- [20] Quan, Houde and Zhao, Huan and Cui, Peizhang, "Anti-jamming Frequency Hopping System Using Multiple Hopping Patterns," *Wireless Personal Communications*, vol. 81, no. 3, pp. 1159–1176, apr 2015. [Online]. Available: <http://dx.doi.org/10.1007/s11277-014-2177-1>